

DIMENSIONAL SPECIFICATIONS

LEAD-FREE IMPORT BRASS FITTINGS* 125 LB.

90 DEGREE ELBOW

Part#	Size (IN.)	Approx. Net WT. (LB.)	A	B
XNL101-02	1/8	0.08	0.55	0.26
XNL101-04	1/4	0.10	0.72	0.35
XNL101-06	3/8	0.17	0.83	0.37
XNL101-08	1/2	0.24	1.03	0.45
XNL101-12	3/4	0.40	1.19	0.52
XNL101-16	1	0.64	1.43	0.60
XNL101-20	1-1/4	0.96	1.71	0.67
XNL101-24	1-1/2	1.16	1.87	0.70
XNL101-32	2	2.07	2.14	0.76
XNL101-40	2-1/2	3.83	2.74	0.93
XNL101-48	3	4.62	3.10	1.00
XNL101-64	4	7.70	3.80	1.10

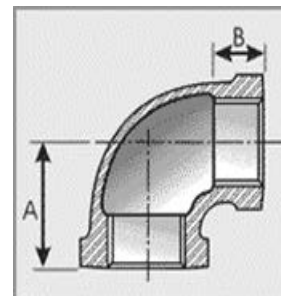

90 DEGREE STREET ELBOW

Part #	Size (IN.)	Approx. Net WT. (LB.)	A	B	C
XNL103-02	1/8	0.07	0.55	0.92	0.28
XNL103-04	1/4	0.11	0.72	1.11	0.32
XNL103-06	3/8	0.16	0.83	1.24	0.35
XNL103-08	1/2	0.24	1.03	1.51	0.45
XNL103-12	3/4	0.36	1.19	1.66	0.50
XNL103-16	1	0.62	1.43	1.98	0.58
XNL103-20	1-1/4	1.03	1.71	2.26	0.67
XNL103-24	1-1/2	1.27	1.87	2.46	0.75
XNL103-32	2	2.09	2.14	2.98	0.78
XNL103-40	2-1/2	4.05	2.74	3.92	0.92
XNL103-48	3	6.38	3.10	4.45	0.98
XNL103-64	4	11.44	3.80	5.63	1.08

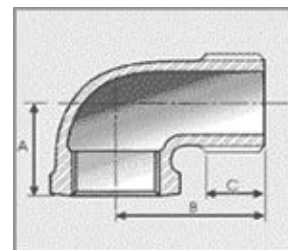

*Conforms with lead content requirements for lead-free plumbing as defined by the U.S. Safe Drinking Water Act. Certified <0.25 weighted average % lead.



MERIT BRASS

DIRECTING THE FLOW OF *Quality*

DIMENSIONAL SPECIFICATIONS

LEAD-FREE IMPORT BRASS FITTINGS* 125 LB.

90 DEGREE REDUCING ELBOW

Part #	Size (IN.)	Approx. Net WT. (LB.)	A	B	C
XNL101-0402	1/4 X 1/8	0.09	0.67	0.81	0.88
XNL101-0604	3/8 X 1/4	0.15	0.81	1.00	0.92
XNL101-0806	1/2 X 3/8	0.23	0.81	1.17	1.17
XNL101-1204	3/4 X 1/4	0.26	0.81	1.42	1.35
XNL101-1206	3/4 X 3/8	0.30	1.00	1.42	1.35
XNL101-1208	3/4 X 1/2	0.31	1.17	1.42	1.35
XNL101-1608	1 X 1/2	0.53	1.17	1.72	1.56
XNL101-1612	1 X 3/4	0.59	1.42	1.72	1.56
XNL101-2012	1-1/4 X 3/4	0.73	1.42	2.10	1.77
XNL101-2016	1-1/4 X 1	0.88	1.72	2.10	1.77
XNL101-2412	1-1/2 X 3/4	1.00	1.72	2.10	1.77
XNL101-2416	1-1/2 X 1	0.99	1.72	2.38	1.80
XNL101-2420	1-1/2 X 1-1/4	1.22	2.10	2.38	1.80
XNL101-3212	2 X 3/4	1.21	2.10	2.92	2.03
XNL101-3216	2 X 1	1.30	2.10	2.92	2.03
XNL101-3220	2 X 1-1/4	1.51	2.10	2.92	2.03
XNL101-3224	2 X 1-1/2	1.69	2.38	2.92	2.03
XNL101-4032	2-1/2 X 2	1.21	2.92	3.49	3.15
XNL101-4840	3 X 2-1/2	4.09	3.49	4.20	3.69

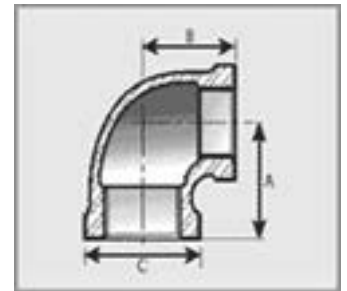

*Conforms with lead content requirements for lead-free plumbing as defined by the U.S. Safe Drinking Water Act. Certified <0.25 weighted average % lead.



MERIT BRASS

DIRECTING THE FLOW OF *Quality*

DIMENSIONAL SPECIFICATIONS

LEAD-FREE IMPORT BRASS FITTINGS* 125 LB.

45 DEGREE ELBOW

Part #	Size (IN.)	Approx. Net WT. (LB.)	A	B
XNL102-02	1/8	0.08	0.43	0.43
XNL102-04	1/4	0.11	0.55	0.55
XNL102-06	3/8	0.12	0.63	0.63
XNL102-08	1/2	0.25	0.79	0.79
XNL102-12	3/4	0.34	0.91	0.91
XNL102-16	1	0.54	1.07	1.07
XNL102-20	1-1/4	0.90	1.23	1.23
XNL102-24	1-1/2	1.03	1.31	1.31
XNL102-32	2	1.54	1.47	1.47
XNL102-40	2-1/2	3.30	1.98	1.98
XNL102-48	3	3.52	2.18	2.18
XNL102-64	4	8.01	2.62	2.62

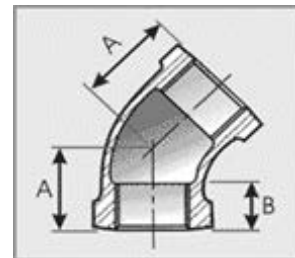

45 DEGREE STREET ELBOW

Part #	Size (IN.)	Approx. Net WT. (LB.)	A	B	C	D
XNL103A-02	1/8	0.06	0.26	0.43	0.28	0.79
XNL103A-08	1/2	0.29	0.45	0.79	0.45	1.07
XNL103A-12	3/4	0.31	0.52	0.91	0.50	1.23
XNL103A-16	1	0.52	0.60	1.07	0.58	1.42
XNL103A-20	1-1/4	0.90	0.67	1.23	0.67	1.65
XNL103A-24	1-1/2	0.97	0.70	1.31	0.75	1.83
XNL103A-32	2	2.04	0.76	1.47	0.78	2.14

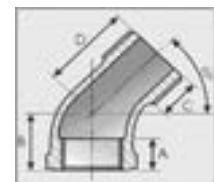

*Conforms with lead content requirements for lead-free plumbing as defined by the U.S. Safe Drinking Water Act. Certified <0.25 weighted average % lead.



MERIT BRASS

DIRECTING THE FLOW OF *Quality*

DIMENSIONAL SPECIFICATIONS

LEAD-FREE IMPORT BRASS FITTINGS* 125 LB.

TEE

Part #	Size (IN.)	Approx. Net WT. (LB.)	A	B	C
XNL106-02	1/8	0.09	0.55	0.26	0.67
XNL106-04	1/4	0.16	0.72	0.35	0.81
XNL106-06	3/8	0.25	0.83	0.37	1.00
XNL106-08	1/2	0.34	1.03	0.45	1.17
XNL106-12	3/4	0.52	1.19	0.52	1.42
XNL106-16	1	0.86	1.43	0.60	1.72
XNL106-20	1-1/4	1.18	1.71	0.67	2.10
XNL106-24	1-1/2	1.56	1.87	0.70	2.38
XNL106-32	2	2.62	2.14	0.76	2.92
XNL106-40	2-1/2	5.28	2.74	0.93	3.49
XNL106-48	3	5.98	3.10	1.00	4.20
XNL106-64	4	13.28	3.80	1.10	5.31

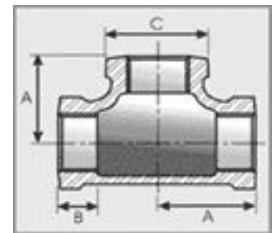

*Conforms with lead content requirements for lead-free plumbing as defined by the U.S. Safe Drinking Water Act. Certified <0.25 weighted average % lead.

MERIT BRASS

DIRECTING THE FLOW OF *Quality*

DIMENSIONAL SPECIFICATIONS

LEAD-FREE IMPORT BRASS FITTINGS* 125 LB.

REDUCING TEE

Part #	Size (IN.)	Approx. Net WT. (LB.)	A	B	C
XNL106-040402	1/4 X 1/4 X 1/8	0.11	0.65	0.65	0.60
XNL106-060604	3/8 X 3/8 X 1/4	0.19	0.75	0.75	0.78
XNL106-080804	1/2 X 1/2 X 1/4	0.28	0.87	0.87	0.87
XNL106-080806	1/2 X 1/2 X 3/8	0.29	0.93	0.93	0.90
XNL106-080812	1/2 X 1/2 X 3/4	0.43	1.22	1.22	1.20
XNL106-120808	3/4 X 1/2 X 1/2	0.43	1.20	1.12	1.22
XNL106-120812	3/4 X 1/2 X 3/4	0.49	1.37	1.31	1.45
XNL106-121206	3/4 X 3/4 X 3/8	0.46	1.00	1.00	1.00
XNL106-121208	3/4 X 3/4 X 1/2	0.53	1.08	1.08	1.11
XNL106-121216	3/4 X 3/4 X 1	0.70	1.22	1.22	1.20
XNL106-160808	1 X 1/2 X 1/2	0.53	1.31	1.22	1.31
XNL106-161208	1 X 3/4 X 1/2	0.67	1.26	1.20	1.36
XNL106-161212	1 X 3/4 X 3/4	0.67	1.37	1.31	1.45
XNL106-161604	1 X 1 X 1/4	0.73	1.04	1.04	1.13
XNL106-161608	1 X 1 X 1/2	0.73	1.20	1.20	1.24
XNL106-161612	1 X 1 X 3/4	0.83	1.30	1.30	1.31
XNL106-202012	1-1/4 X 1-1/4 X 3/4	1.03	1.30	1.30	1.31
XNL106-202016	1-1/4 X 1-1/4 X 1	1.03	1.58	1.58	1.67
XNL106-242408	1-1/2 X 1-1/2 X 1/2	1.11	1.32	1.32	1.53
XNL106-242412	1-1/2 X 1-1/2 X 3/4	1.23	1.42	1.42	1.60
XNL106-242416	1-1/2 X 1-1/2 X 1	1.31	1.55	1.55	1.72
XNL106-242420	1-1/2 X 1-1/2 X 1-1/4	1.52	1.72	1.72	1.81
XNL106-323208	2 X 2 X 1/2	1.65	1.49	1.49	1.88
XNL106-323212	2 X 2 X 3/4	1.87	1.47	1.47	1.84
XNL106-323216	2 X 2 X 1	1.91	1.60	1.60	1.98
XNL106-323220	2 X 2 X 1-1/4	2.20	1.77	1.77	2.04
XNL106-323224	2 X 2 X 1-1/2	3.08	2.02	2.02	2.16

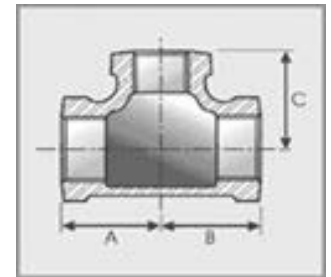

*Conforms with lead content requirements for lead-free plumbing as defined by the U.S. Safe Drinking Water Act. Certified <0.25 weighted average % lead.

MERIT BRASS

DIRECTING THE FLOW OF *Quality*

DIMENSIONAL SPECIFICATIONS

LEAD-FREE IMPORT BRASS FITTINGS* 125 LB.

CROSS

Part #	Size (IN.)	Approx. Net WT. (LB.)	A	B	C
XNL110-04	1/4	0.20	0.72	0.34	0.81
XNL110-08	1/2	0.44	1.03	0.45	1.17
XNL110-12	3/4	0.68	1.19	0.52	1.42
XNL110-16	1	1.08	1.43	0.60	1.72
XNL110-24	1-1/2	1.97	1.87	0.70	2.38
XNL110-32	2	2.52	2.14	0.76	2.92

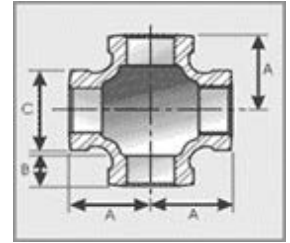

CAP

Part #	Size (IN.)	Approx. Net WT. (LB.)	G1	G2	A
XNL116-02	1/8	0.08	0.08	0.09	0.25
XNL116-04	1/4	0.07	0.08	0.10	0.32
XNL116-06	3/8	0.09	0.09	0.11	0.36
XNL116-08	1/2	0.13	0.09	0.12	0.45
XNL116-12	3/4	0.22	0.10	0.13	0.50
XNL116-16	1	0.40	0.11	0.15	0.58
XNL116-20	1-1/4	0.48	0.12	0.17	0.67
XNL116-24	1-1/2	0.72	0.13	0.19	0.70
XNL116-32	2	1.11	0.15	0.22	0.75
XNL116-40	2-1/2	1.75	0.17	0.25	0.92
XNL116-48	3	2.71	0.19	0.29	0.98
XNL116-64	4	4.64	0.22	0.36	1.08

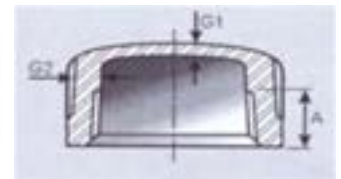

*Conforms with lead content requirements for lead-free plumbing as defined by the U.S. Safe Drinking Water Act. Certified <0.25 weighted average % lead.



MERIT BRASS

DIRECTING THE FLOW OF *Quality*

DIMENSIONAL SPECIFICATIONS

LEAD-FREE IMPORT BRASS FITTINGS* 125 LB.

COUPLING

Part #	Size (IN.)	Approx. Net WT. (LB.)	A	B	C
XNL111-02	1/8	0.06	0.56	0.26	0.80
XNL111-04	1/4	0.08	0.69	0.26	0.80
XNL111-06	3/8	0.14	0.84	0.36	1.05
XNL111-08	1/2	0.21	1.06	0.43	1.29
XNL111-12	3/4	0.30	1.31	0.50	1.43
XNL111-16	1	0.47	1.70	0.58	1.68
XNL111-20	1-1/4	0.56	2.03	0.67	1.86
XNL111-24	1-1/2	1.03	2.30	0.70	1.92
XNL111-32	2	1.06	2.81	0.75	2.20
XNL111-40	2-1/2	2.77	3.59	0.94	2.88
XNL111-48	3	2.75	4.16	0.98	3.18
XNL111-64	4	6.60	5.27	1.08	3.69

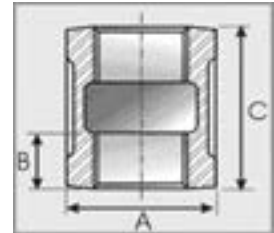

*Conforms with lead content requirements for lead-free plumbing as defined by the U.S. Safe Drinking Water Act. Certified <0.25 weighted average % lead.



MERIT BRASS

DIRECTING THE FLOW OF *Quality*

DIMENSIONAL SPECIFICATIONS

LEAD-FREE IMPORT BRASS FITTINGS* 125 LB.

REDUCING COUPLING

Part #	Size (IN.)	Approx. Net WT. (LB.)	A	B	C
XNL112-0402	1/4 X 1/8	0.08	0.67	0.81	0.88
XNL112-0602	3/8 X 1/8	0.65	0.67	1.00	0.92
XNL112-0604	3/8 X 1/4	0.12	0.81	1.00	0.92
XNL112-0802	1/2 X 1/8	0.15	0.67	1.17	1.17
XNL112-0804	1/2 X 1/4	0.17	0.81	1.17	1.17
XNL112-0806	1/2 X 3/8	0.17	1.00	1.17	1.17
XNL112-1204	3/4 X 1/4	0.23	0.81	1.42	1.35
XNL112-1206	3/4 X 3/8	0.24	1.00	1.42	1.35
XNL112-1208	3/4 X 1/2	0.26	1.17	1.42	1.35
XNL112-1606	1 X 3/8	0.41	1.00	1.72	1.56
XNL112-1608	1 X 1/2	0.39	1.17	1.72	1.56
XNL112-1612	1 X 3/4	0.45	1.42	1.72	1.56
XNL112-2008	1-1/4 X 1/2	0.59	1.17	2.10	1.77
XNL112-2012	1-1/4 X 3/4	0.67	1.42	2.10	1.77
XNL112-2016	1-1/4 X 1	0.72	1.72	2.10	1.77
XNL112-2408	1-1/2 X 1/2	0.85	1.17	2.38	1.80

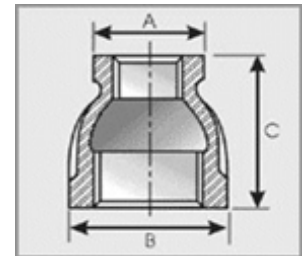

*Conforms with lead content requirements for lead-free plumbing as defined by the U.S. Safe Drinking Water Act. Certified <0.25 weighted average % lead.



MERIT BRASS

DIRECTING THE FLOW OF *Quality*

DIMENSIONAL SPECIFICATIONS

LEAD-FREE IMPORT BRASS FITTINGS* 125 LB.

REDUCING COUPLING CONTINUED

Part #	Size (IN.)	Approx. Net WT. (LB.)	A	B	C
XNL112-2412	1-1/2 X 3/4	0.92	1.42	2.38	1.80
XNL112-2416	1-1/2 X 1	0.90	1.72	2.38	1.80
XNL112-2420	1-1/2 X 1-1/4	0.99	2.10	2.38	1.80
XNL112-3208	2 X 1/2	1.28	1.17	2.92	2.03
XNL112-3212	2 X 3/4	1.25	1.42	2.92	2.03
XNL112-3216	2 X 1	1.39	1.72	2.92	2.03
XNL112-3220	2 X 1-1/4	1.05	2.10	2.92	2.03
XNL112-3224	2 X 1-1/2	1.74	2.38	2.92	2.03
XNL112-4020	2-1/2 X 1-1/4	2.08	2.10	3.49	3.25
XNL112-4024	2-1/2 X 1-1/2	1.94	2.38	3.49	3.25
XNL112-4032	2-1/2 X 2	2.11	2.92	3.49	3.25
XNL112-4824	3 X 1-1/2	2.35	2.92	4.20	3.69
XNL112-4832	3 X 2	2.40	2.92	4.20	3.69
XNL112-4840	3 X 2-1/2	2.40	3.49	4.20	3.69
XNL112-6448	4 X 3	4.58	4.20	5.31	4.38

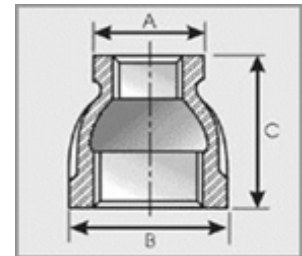

*Conforms with lead content requirements for lead-free plumbing as defined by the U.S. Safe Drinking Water Act. Certified <0.25 weighted average % lead.



MERIT BRASS

DIRECTING THE FLOW OF *Quality*

DIMENSIONAL SPECIFICATIONS

LEAD-FREE IMPORT BRASS FITTINGS* 125 LB.

HEX BUSHING

Part #	Size (IN.)	Approx. Net WT. (LB.)	A	B	C
XNL114-0802	1/2 X 1/8	0.10	0.56	0.25	0.19
XNL114-0804	1/2 X 1/4	0.09	0.56	0.32	0.19
XNL114-0806	1/2 X 3/8	0.07	0.56	0.41	0.19
XNL114-1202	3/4 X 1/8	0.17	0.63	0.38	0.25
XNL114-1204	3/4 X 1/4	0.17	0.63	0.32	0.22
XNL114-1206	3/4 X 3/8	0.16	0.63	0.36	0.22
XNL114-1208	3/4 X 1/2	0.11	0.63	0.53	0.22
XNL114-1604	1 X 1/4	0.24	0.75	0.32	0.30
XNL114-1606	1 X 3/8	0.22	0.75	0.36	0.30
XNL114-1608	1 X 1/2	0.21	0.75	0.43	0.25
XNL114-1612	1 X 3/4	0.24	0.75	0.50	0.25
XNL114-2004	1-1/4 X 1/4	0.34	0.80	0.32	0.34
XNL114-2006	1-1/4 X 3/8	0.40	0.81	0.38	0.34
XNL114-2008	1-1/4 X 1/2	0.47	0.80	0.43	0.34
XNL114-2012	1-1/4 X 3/4	0.41	0.80	0.50	0.28
XNL114-2016	1-1/4 X 1	0.39	0.80	0.58	0.28
XNL114-2404	1-1/2 X 1/4	0.43	0.81	0.32	0.34
XNL114-2406	1-1/2 X 3/8	0.45	0.81	0.36	0.34

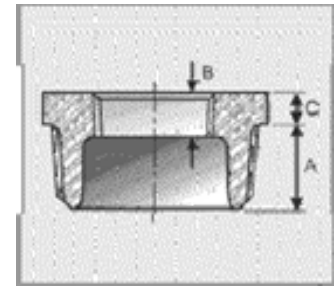

*Conforms with lead content requirements for lead-free plumbing as defined by the U.S. Safe Drinking Water Act. Certified <0.25 weighted average % lead.



MERIT BRASS

DIRECTING THE FLOW OF *Quality*

DIMENSIONAL SPECIFICATIONS

LEAD-FREE IMPORT BRASS FITTINGS* 125 LB.

HEX BUSHING CONTINUED

Part #	Size (IN.)	Approx. Net WT. (LB.)	A	B	C
XNL114-2408	1-1/2 X 1/2	0.72	0.83	0.43	0.37
XNL114-2412	1-1/2 X 3/4	0.50	0.83	0.50	0.37
XNL114-2416	1-1/2 X 1	0.49	0.83	0.58	0.31
XNL114-2420	1-1/2 X 1-1/4	0.43	0.83	0.71	0.31
XNL114-3208	2 X 1/2	1.10	0.88	0.43	0.43
XNL114-3212	2 X 3/4	1.15	0.88	0.50	0.43
XNL114-3216	2 X 1	1.02	0.88	0.58	0.41
XNL114-3220	2 X 1-1/4	0.87	0.88	0.67	0.34
XNL114-3224	2 X 1-1/2	0.81	0.88	0.70	0.34
XNL114-4016	2-1/2 X 1	1.76	1.09	0.59	0.44
XNL114-4020	2-1/2 X 1-1/4	1.67	1.09	0.69	0.44
XNL114-4024	2-1/2 X 1-1/2	1.15	1.09	0.72	0.44
XNL114-4032	2-1/2 X 2	5.98	1.07	0.75	0.37
XNL114-4824	3 X 1-1/2	2.44	1.13	0.72	0.50
XNL114-4832	3 X 2	1.70	1.13	0.75	0.48
XNL114-4840	3 X 2-1/2	1.69	1.13	0.92	0.40
XNL114-6432	4 X 2	3.16	1.22	0.75	0.60
XNL114-6448	4 X 3	3.74	1.22	0.98	0.50

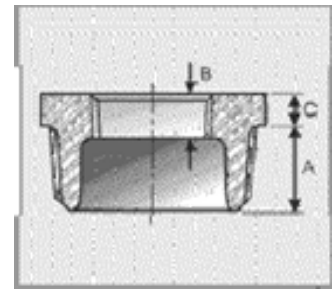

*Conforms with lead content requirements for lead-free plumbing as defined by the U.S. Safe Drinking Water Act. Certified <0.25 weighted average % lead.

MERIT BRASS

DIRECTING THE FLOW OF *Quality*

DIMENSIONAL SPECIFICATIONS

LEAD-FREE IMPORT BRASS FITTINGS* 125 LB.

SQUARE HEAD CORED PLUG

Part #	Size (IN.)	Approx. Net WT. (LB.)	A	B	C
XNL117-08	1/2	0.11	0.54	0.56	0.38
XNL117-12	3/4	0.16	0.55	0.63	0.44
XNL117-16	1	0.25	0.69	0.81	0.50
XNL117-20	1-1/4	0.38	0.71	0.94	0.56
XNL117-24	1-1/2	0.52	0.73	1.13	0.62
XNL117-32	2	0.83	0.76	1.31	0.68
XNL117-40	2-1/2	1.26	1.07	1.50	0.74
XNL117-48	3	1.49	1.13	1.69	0.80
XNL117-64	4	3.20	1.22	2.25	0.92

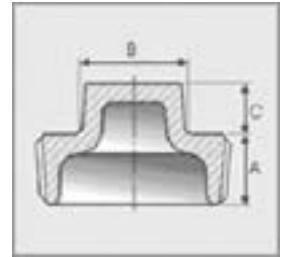

SQUARE HEAD SOLID PLUG

Part #	Size (IN.)	Approx. Net WT. (LB.)	A	B	C
XNL117A-06	3/8	0.07	0.41	0.44	0.31
XNL117A-08	1/2	0.12	0.54	0.56	0.38
XNL117A-12	3/4	0.18	0.55	0.63	0.44
XNL117A-16	1	0.38	0.69	0.81	0.50
XNL117A-20	1-1/4	0.59	0.71	0.94	0.56
XNL117A-24	1-1/2	0.89	0.73	1.13	0.62
XNL117A-32	2	1.39	0.76	1.31	0.68
XNL117A-40	2-1/2	2.35	1.07	1.50	0.74
XNL117A-48	3	3.59	1.13	1.69	0.80
XNL117A-64	4	6.82	1.22	2.25	0.92

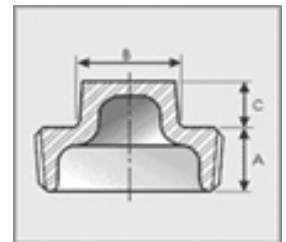

*Conforms with lead content requirements for lead-free plumbing as defined by the U.S. Safe Drinking Water Act. Certified <0.25 weighted average % lead.



MERIT BRASS

DIRECTING THE FLOW OF *Quality*

DIMENSIONAL SPECIFICATIONS

LEAD-FREE IMPORT BRASS FITTINGS* 125 LB.

HEX LOCKNUT

Part #	Size (IN.)	Approx. Net WT. (LB.)	A	B	C
XNL119-02	1/8	0.03	0.19	0.50	0.04
XNL119-04	1/4	0.03	0.25	0.66	0.06
XNL119-06	3/8	0.04	0.28	0.77	0.06
XNL119-08	1/2	0.10	0.31	0.97	0.06
XNL119-12	3/4	0.13	0.34	1.23	0.06
XNL119-16	1	0.20	0.38	1.50	0.06
XNL119-20	1-1/4	0.29	0.42	1.86	0.06
XNL119-24	1-1/2	0.52	0.47	2.12	0.06
XNL119-32	2	0.64	0.53	2.63	0.09

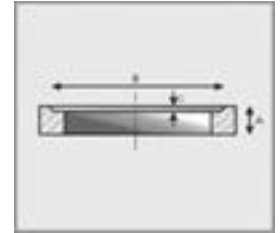

UNION

Part #	Size (IN.)	Approx. Net WT. (LB.)	A
XNL187-02	1/8	0.13	1.17
XNL187-04	1/4	0.22	1.25
XNL187-06	3/8	0.39	1.48
XNL187-08	1/2	0.47	1.56
XNL187-12	3/4	0.69	1.87
XNL187-16	1	1.03	2.11
XNL187-20	1-1/4	1.52	2.34
XNL187-24	1-1/2	2.09	2.65
XNL187-32	2	3.12	2.96
XNL187-40	2-1/2	5.39	3.32
XNL187-48	3	6.49	3.71
XNL187-64	4	5.20	4.60

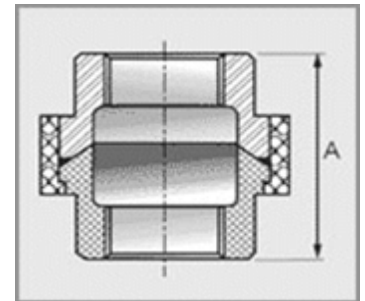

*Conforms with lead content requirements for lead-free plumbing as defined by the U.S. Safe Drinking Water Act. Certified <0.25 weighted average % lead.

MERIT BRASS

DIRECTING THE FLOW OF *Quality*